

ISTRUZIONI PER L'USO

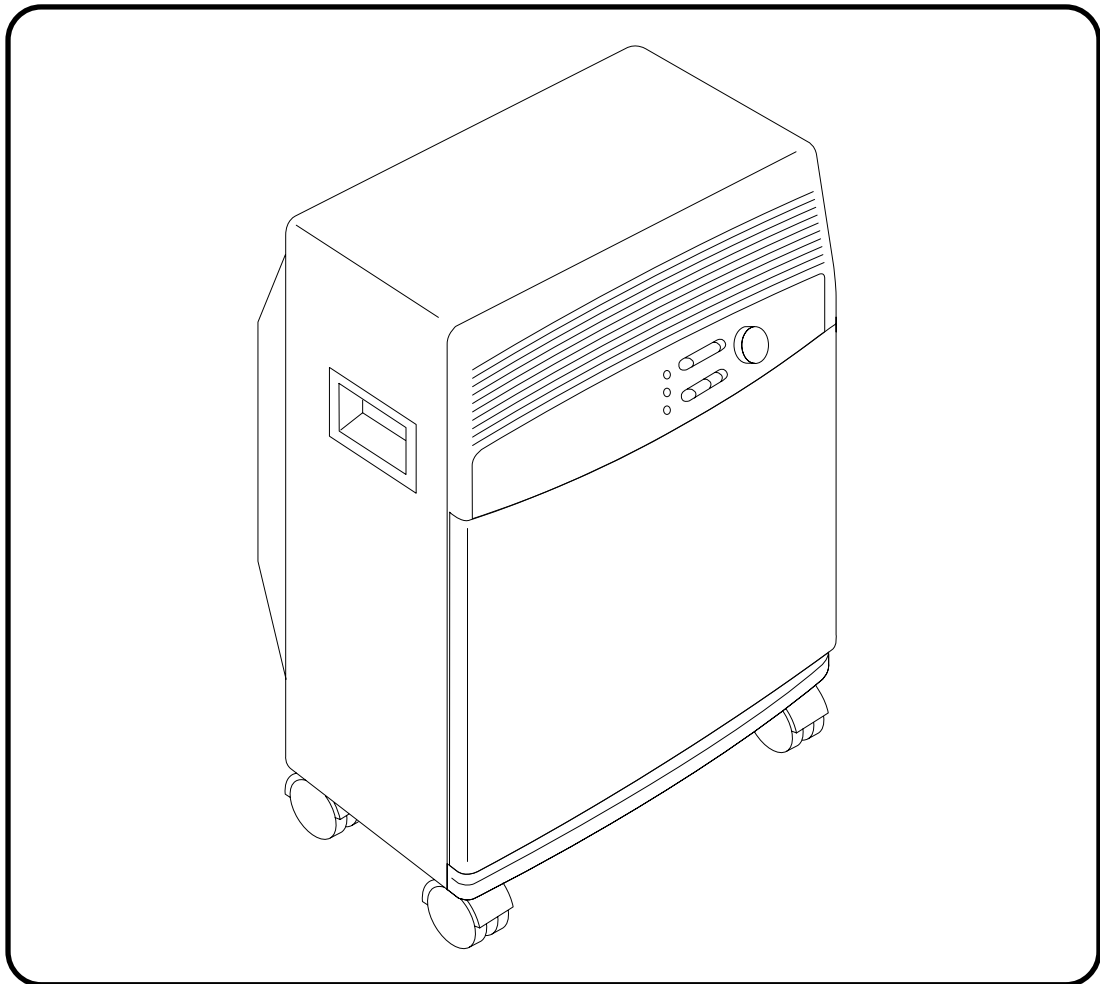

## Climatizzatore CT300 - CT300H



**DēLonghi**

*Dear Sir/Madam*

*We thank you for purchasing this Pinguino appliance and congratulate you on your wise choice.*

*Please make the time and effort to read this manual carefully.*

*Becoming familiar with the Pinguino is an essential step if you are to benefit fully from its exceptional qualities, during both installation and actual use.*

*We hope that the Pinguino will become a welcome friend this summer, a source of comfort and refreshment.*

*Best wishes*

*De Longhi S.p.A.*

## GENERAL DESCRIPTION

Pinguino is a very versatile air conditioner because it can operate both through water condensation as well as air condensation.

The User may choose the operational method:

- 1) **WATER FUNCTION** - When excellent efficiency, lower energy consumption, and greater speed in reaching the ideal climatic conditions are desired. This function is especially useful when the appliance is just turned on and when the room temperature is quite warm.

When the water reserve (in the tank) has been used up, Pinguino automatically changes to the air functioning mode.

- 2) **AIR FUNCTION** - This is the normal air conditioning function.

## TECHNICAL DATA

Tab.1

		WATER FUNCTION - AIR FUNCTION
Power supply voltage	(V)	220...240 V ~
Frequency	(Hz)	50
Electric power consumption	(A)	3,85 - 4,45
Max.power consumption (air-condit.mode)	(W)	see rating label
*Max.power consumption (heating mode)	(W)	see rating label
Cooling capacity	(Frig/h, W, Btu/h)	see rating label
Cooling capacity	(Frig/h, W, Btu/h)	see rating label
Air flow capacity	(m <sup>3</sup> /h)	360
Timer		24 h
Dimensions: width	(mm)	560
height		735
depth		390
Net weight	(kg)	44
Technical data subject to change without prior notice		

\* Model CT250H only

## IDEAL OPERATING CONDITIONS

Tab.2

ROOM TEMPERATURE	21 ÷ 35°C
ROOM HUMIDITY FACTOR	BELOW 80%

**Note:** When indoor temperature exceeds 32°C, the appliance should be operated with water.

## IDEAL OPERATING HEATING CONDITIONS



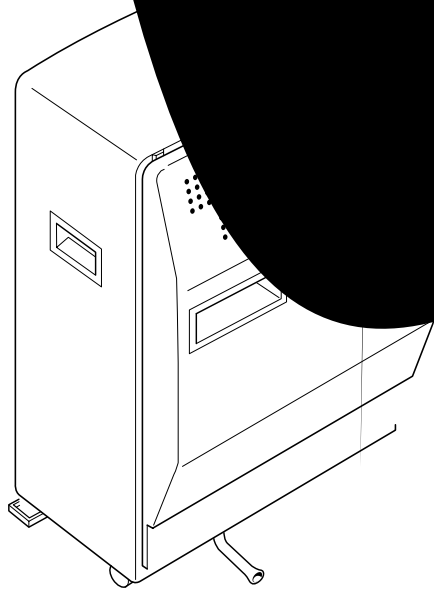

Tab. 3

ROOM TEMPERATURE	max 5° C
------------------	----------

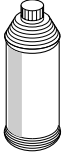

## DESCRIPTION OF ACCESSORIES

Tab. 5

	DESCRIPTION	PARTS SUPPLIED
	Exhaust hose	1
	Stopper + flange	1
	Castor stop	2
	De-scaling fluid	1
	Window nozzle	1
	Suction cup set	1

The appli

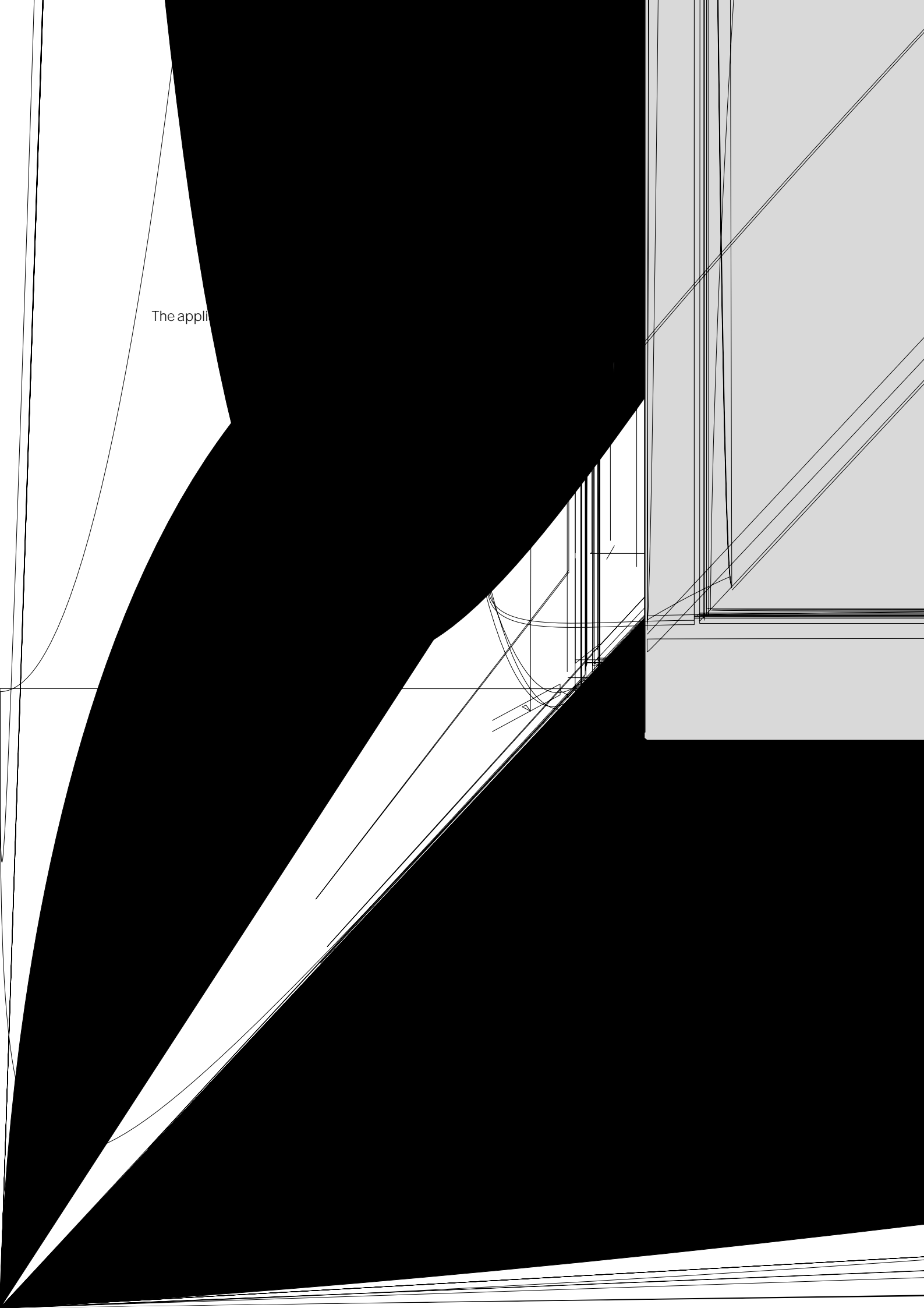

Height of outlet:  
within the range indicated by the dotted line in the figure below.

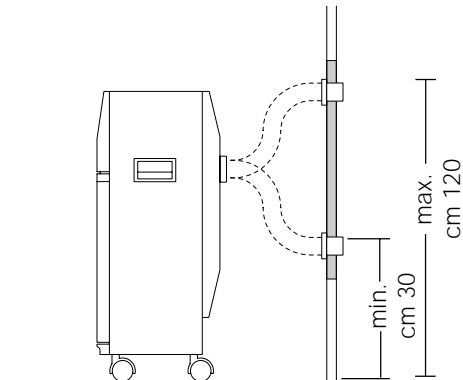

When the unit is not in use, the outlet hole should be sealed with the stopper supplied.

**Temporary installation:** The outlet holes can be connected in a number of ways:

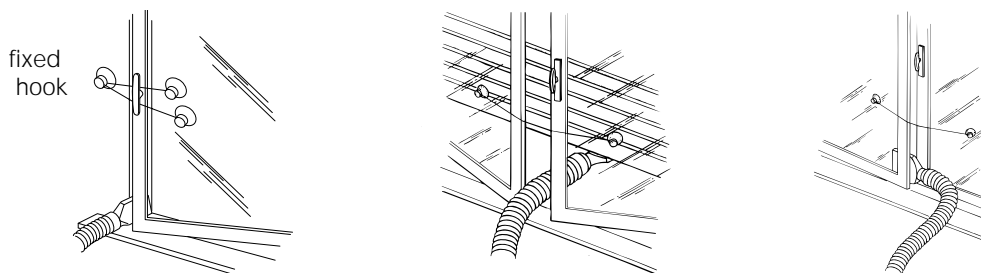

In any event, for maximum cooling efficiency the window should be closed as much as possible.

It is advisable :

- to keep the outlet free of any obstruction;
- to lower the blind partially, without obstructing the outlet, thereby reducing exposure to direct sunlight and indoor/outdoor air exchange.

## **INSTALLATION FOR HEATING FUNCTION (Model CT300H)**

The unit is simply placed in the room to be heated; there is no need for the discharge hose to be installed.

## **ELECTRICAL CONNECTIONS**

- The mains supply, suitable for domestic electrical appliances, must correspond to the power requirements of the air conditioner (power consumption value shown in Table 1).
- Check that the power supply voltage is: 220/240 V-50 Hz
- Check that the mains socket is correctly earthed.

**Note:** In the case that the power cable becomes damaged, this must be substituted only by specialised personnel authorised by the manufacturer.

**THIS APPLIANCE IS MANUFACTURED TO COMPLY WITH THE RADIO INTERFERENCE REQUIREMENTS PROVIDED BY COUNCIL DIRECTIVE EN 55014.**

## PREPARING THE UNIT FOR USE

the exhaust hose; if your conditioner is supplied with a bayonet fitting, the hose is illustrated in the diagram. For perforated surfaces, place the appliance near a window outlet. Make sure it is on a flat surface and fit the special castor stops under the path of the hose. The hose should be compressed or bent to a minimum of 100 mm. and 1400 mm.,

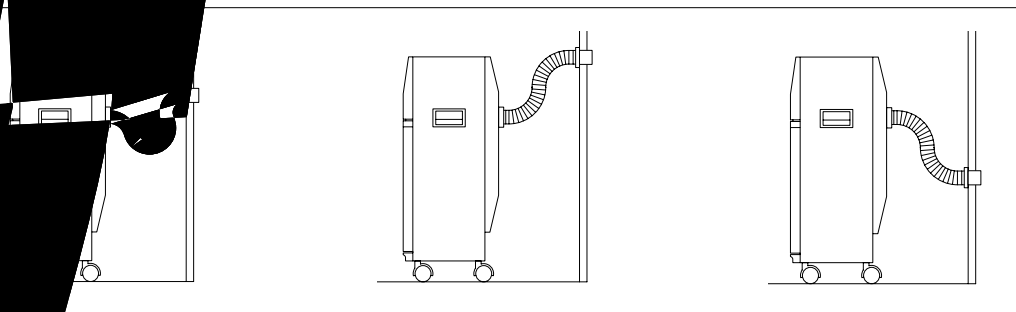

best used at minimum length. **Never stretch the hose.**

## HOW TO PREPARE WATER CONTAINER

Use clean, salt-free tap water. The water is essential for the air cooling operation and is discharged as a form of steam through the exhaust outlet. A container full of water lasts for a period that depends on a number of conditions such as temperature, humidity, insulation, exposure of the room, number of people present, etc. On average it will last approximately 7 to 10 hours. When the container is empty, the appliance automatically changes function from water to air. At the same time the quantity of air discharged from the rear hose will increase.

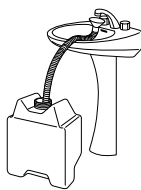

Open the water container compartment door, tip the container forwards and lift up to remove.

Remove the cap, pull out the extendable tube and fill the container, standing it on the floor.



After filling, replace the extendable tube, screw the cap on tightly and return the container to its place, making sure the word FRONT is facing out.

During "water condensation" cooling function and in particularly quiet surroundings (eg. bedroom), a slight gurgling noise may be heard. This may be regarded as perfectly normal.

Attention: Do not use water which has been decalcified through the use of a water softener.



## AIR COOLING FUNCTION

If the air cooling function of air-conditioner is chosen, it is not necessary to fill the water container.

## FINAL CHECK

In order to obtain maximum performance from your air-conditioner, make sure that:

- doors and windows in the room to be air-conditioned are closed (except for temporary installation, in which case a window must be left partially open).



CLOSE THE WINDOWS

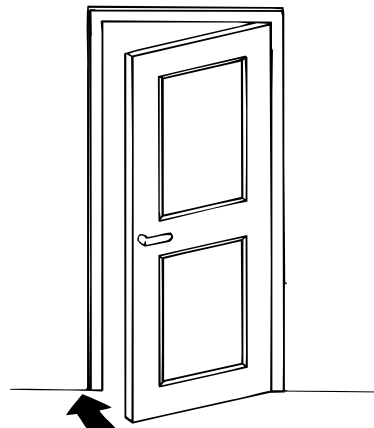

CLOSE THE DOORS

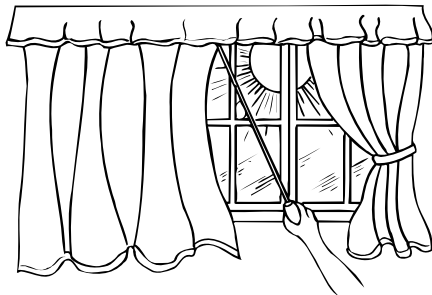

DRAW THE CURTAINS

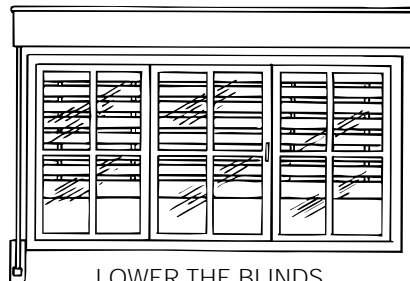

LOWER THE BLINDS

- the room is well shaded from direct sunlight by drawing curtains and/or partially lowering blinds or shutters, to avoid excessive energy consumption

- the intake and outlet vents are free of any obstruction at all times
- there are no sources of heat in the room.

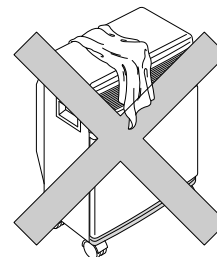

DO NOT COVER

THE AIR-CONDITIONER IS NOW READY FOR USE, so let's now take a look at the controls.

## CONTROL PANEL (Mod. CT300H)

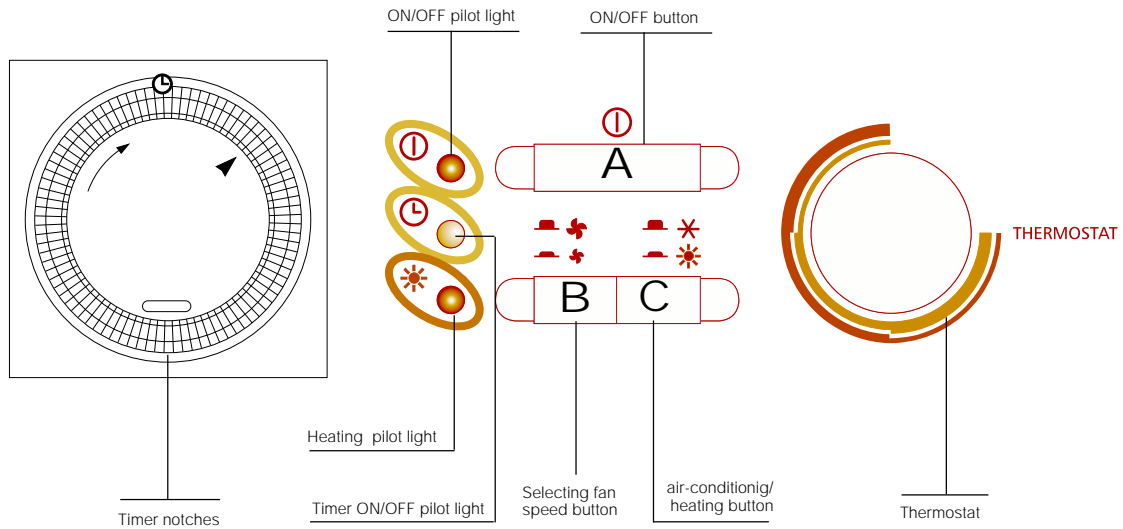

### SETTING THE TIMER

The programmer/timer, like all clocks, must be set to the exact time. If for example it is 4:00 p.m. (16.00), turn the dial in a clockwise direction (following the direction of the arrow) until the number 16 is lined up with the triangular pointer (the arrows indicates 4:00 p.m. approximately).

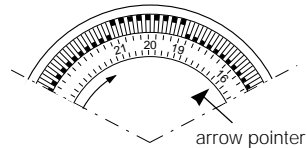

**Note:** Never turn the dial in an anti-clockwise direction!

The timer is in effect, an electric clock and works only if the plug is connected to the power supply. Whenever the plug is disconnected or there is a power failure, the programmer stops (the clock is then "slow") and must be re-set.

The unit can be used in either **programmed** or **non-programmed** mode.

### PROGRAMMED MODE

- 1) Position the timer switch in the **TIMER ON** position (the **TIMER ON/OFF** warning light on the control panel will light up).
- 2) Set the operating times by pushing out the notches on the dial corresponding to the period required (each notch represents 15 mins.)
- 3) Check that the timer indicates the correct time (see instructions on setting).

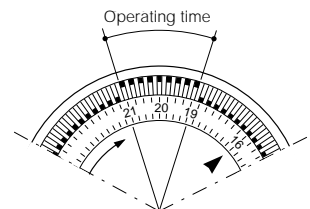

- 4) Select the desired function as shown in the chart overleaf. The unit will now switch on and off each day at the selected times.

### NON-PROGRAMMED MODE

In case the programmed functioning is not desired, it is not necessary to vary the program; in this case, it will be sufficient to turn the **TIMER** to the **OFF** position.

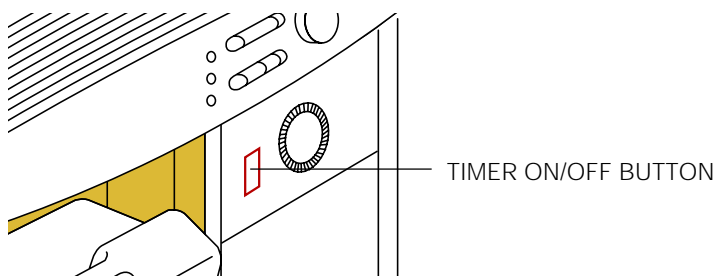

## HOW TO START UP THE CONDITIONER (Mod. CT300H) (see control panel on the opposite page)

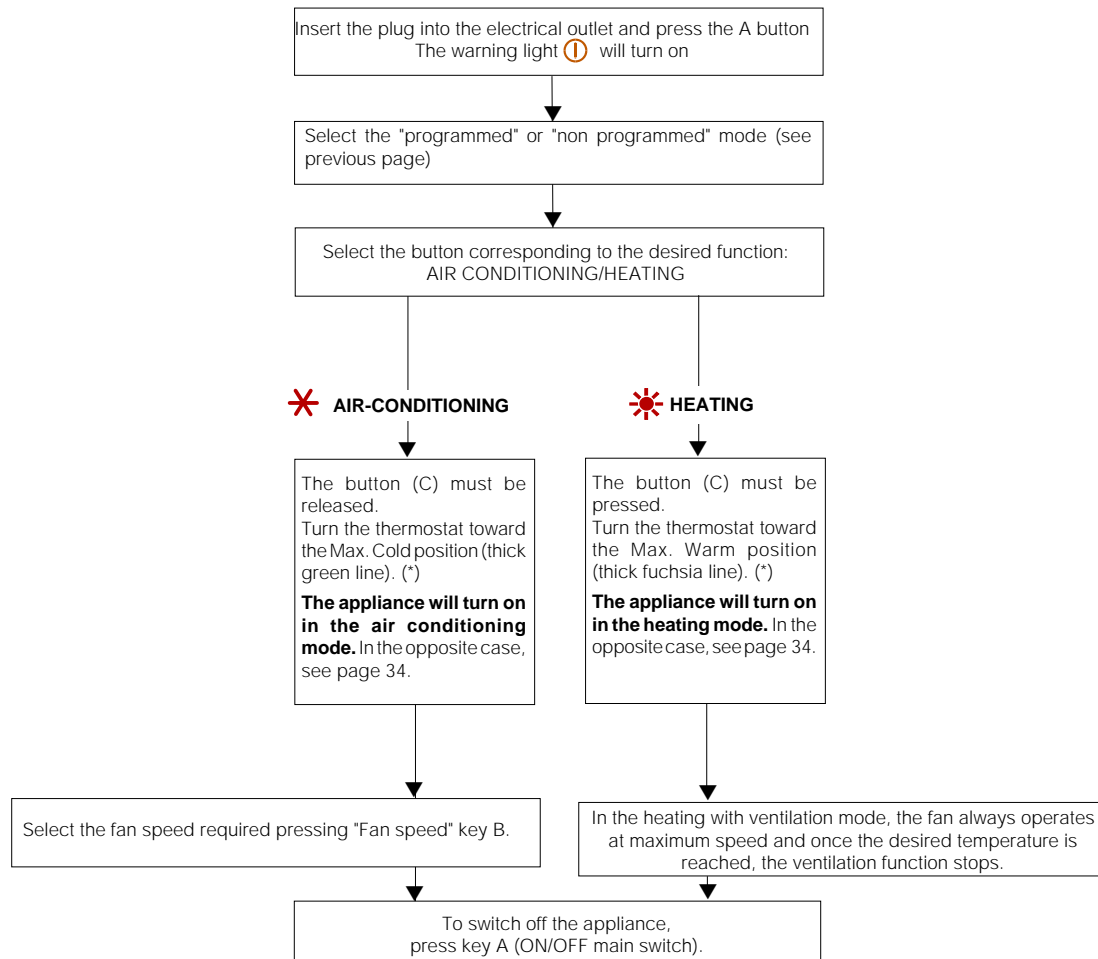

**Nota: The "TIMER ON" pilot light will only come on with programmed mode.**

(\*) **Note** We therefore recommend that when starting up the appliance, the thermostat be turned to maximum (thick green line = maximum cold). When the desired temperature has been reached, turn the thermostat slowly away from the maximum cooling position until the appliance switches off. Leave the thermostat in this position. The air-conditioner is now programmed to maintain the exact temperature at all times.

## CONTROL PANEL (Mod. CT300)

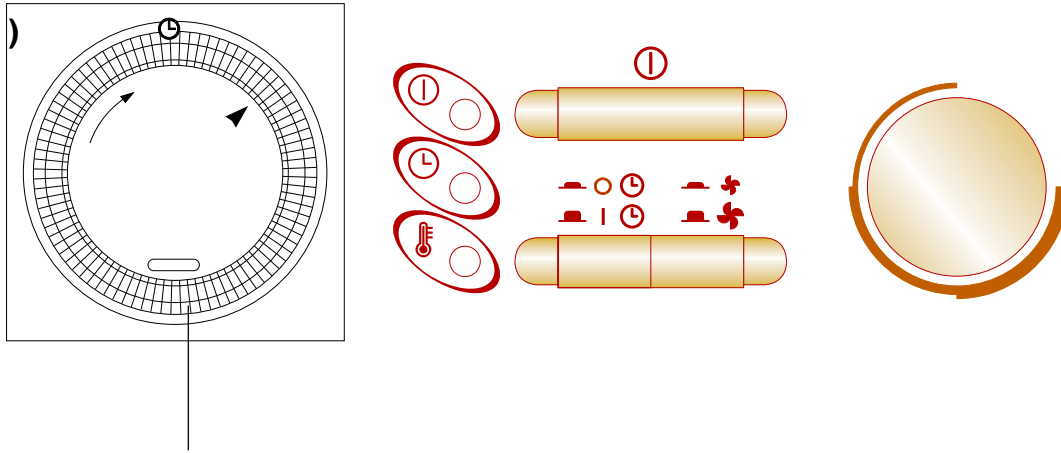

### SETTING THE TIMER

The programmer/timer, like all clocks, must be set to the exact time. If for example it is 4.00 pm. (16.00), turn the dial in a clockwise direction (following the direction of the arrow) until the number 16 is lined up with the triangular pointer (the arrows indicates 4:00 P.M. approximately).

### PROGRAMMED MODE

- 1) Release B TIMER button
- 2) Set the operating times by pushing out the notches on the dial corresponding to the period required (each notch represents 15 mins.)
- 3) Check that the timer indicates the correct time (see instructions on setting).

**Note:** Never turn the dial in an anti-clockwise direction!

The timer is in effect, an electric clock and works only if the plug is connected to the power supply. Whenever the plug is disconnected or there is a power failure, the programmer stops (the clock is then "slow") and must be re-set.

- 4) Select the desired function as shown in the chart overleaf.  
The unit will now switch on and off each day at the selected times.

**Note:** To override the programmed operating times, simply press the ON/OFF key.

The unit can be used in either **programmed** or **non-programmed** mode.

### NON-PROGRAMMED MODE

- 1) B TIMER button must be pressed
- 2) Select the desired function as shown in the chart on the following page.



**After switching the appliance off, wait at least 3 min. before switching on again.**

## HOW TO START UP THE CONDITIONER (Mod. CT250) (see control panel on the opposite page)

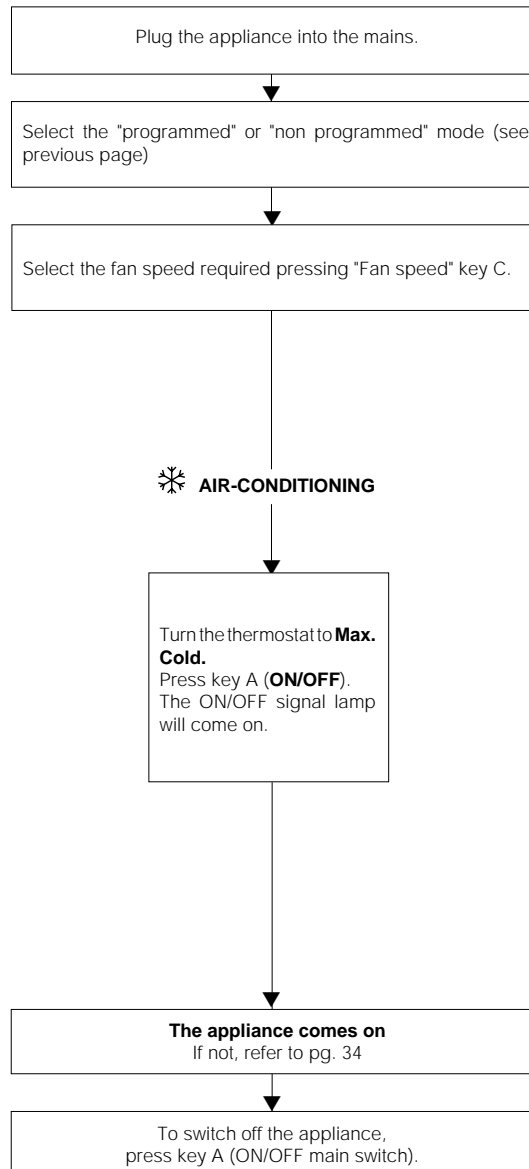

## IMPORTANT WARNINGS

- This appliance has been manufactured for use in home air conditioning and should not be used for other purposes.
- It is dangerous to modify or otherwise alter in any way the characteristics of this appliance.
- The appliance must be installed according to the national technical systems regulations.
- In case reparations should become necessary, please always contact only the Technical Service Centres authorised by the manufacturer. The reparations done to the air conditioner by incompetent or unauthorised technicians can be dangerous.
- This appliance must be used exclusively by adults; do not allow children to play with this electrical appliance.
- This appliance must be connected to an effective grounded power source. Have the electrical system checked by a specialised electrician.
- Avoid the use of extension cords to the power supply cable. In case the use of an extension cord should be necessary, consult a specialised electrician.
- In case the power supply cable should need to be substituted, only authorised personnel should carry out the substitution, and only an H05W-F type cable in a 3X1 mm<sup>2</sup> section should be used.
- Before beginning any cleaning or maintenance operation, always disconnect the appliance plug from the electrical outlet.
- Do not use the power supply cable to pull the appliance when moving it.
- Do not install the appliance in rooms where the air might contain traces of gas, oil, or sulphur, or in the vicinity of heat sources.
- Before moving the air conditioner, drain the water from the condensation pan by using the drainage tube.
- The external extremity of the drainage tube must be left free at all times, in order not to obstruct the elimination of air.
- Do not place heavy or hot objects on top of the appliance.
- Clean the filters at least once a week.
- Remember to carry out the decalcification procedures at the end of each season (see page 35). In locations where the water is particularly hard (rich in lime), it is advisable to add a water-softening agent to it, which can be requested at the Authorised Service Centres.
- Avoid the use of other heating appliances near the air conditioning unit.
- In case that the appliance must be transported, the air conditioning unit must be kept in a vertical position or alternatively, placed on its side. Before transport, empty the water condensation pan and the basin. After transporting the unit, wait at least one hour before turning on the appliance.
- The material used in the packaging is recyclable. It is therefore advisable to place it in the special containers for differentiated refuse collection after unpacking.
- Always wait three minutes before turning the appliance on again.

## SERVICING

**PRECAUTIONS:** during cleaning and normal maintenance operations, remember to disconnect the plug. Under no circumstances should the appliance be washed with running water. Damage could be caused to the electrical circuit.

### AIR-FILTER CLEANING

- A clogged air filter reduces air circulation and the efficiency of the appliance. Clean the filter once a week.
- To remove the filter, pull it up gently. Push down to replace.
- Use a vacuum cleaner to remove dust deposited on the filter. If it is very dirty, soak it in lukewarm water and rinse thoroughly. The temperature of the water must be kept below 40°C. After washing, leave the filter to dry before replacing.

### CLEANING EXTERNAL HOUSING

Clean with a damp cloth and rub over with a clean dry cloth.

**PRECAUTIONS:** never use petrol, oil or similar solvents for cleaning. Never spray insecticides or similar liquids. Serious damage may result to paintwork and plastic.

### CLEANING COLLECTING TRAY

The collecting tray should be cleaned at least once a month to prevent dirt from accumulating after prolonged use.

- 1) Switch off the appliance and disconnect the plug;
- 2) Open the water container compartment door and remove the container;
- 3) Remove the plug from the drainage tube situated at the back of the appliance and empty the water into a bowl;
- 4) Once the container has been fully drained, replace the plug;
- 5) Remove any dirt from the surface below the container, rubbing with a cloth.

## CONTROLS AT BEGINNING OF SEASON

Check that the power supply cable and the plug are in perfect condition.

Make sure that the system has been grounded and that the wire is not frayed and has not become disconnected.

Please make sure to strictly follow the installation instructions.

## END OF SEASON OPERATIONS

- 1) De-scale the unit. (see pg. 35)
- 2) Remove all traces of residual water using the drainage tube placed at the rear of the appliance (see page 22)
- 3) Let the fan run for about half an hour to dry the inside of the air-conditioner
- 4) Switch off the unit and disconnect the plug from the power supply.
- 5) Remove the exhaust hose
- 6) Clean the filter and dry well before replacing
- 7) Cover the appliance with a polythene bag to prevent dust from entering.

## TROUBLESHOOTING

PROBLEM	CAUSE	REMEDY
<b>The air-conditioner does not work</b>	<ul style="list-style-type: none"> <li>power failure</li> <li>plug is disconnected</li> <li>the notches on TIMER dial have not been set</li> <li>The ON /OFF button (A) is in the OFF position</li> </ul>	<ul style="list-style-type: none"> <li>wait</li> <li>connect plug</li> <li>push teeth outwards</li> <li>Press the ON/OFF button</li> </ul>
<b>Ventilation only functions</b>	<ul style="list-style-type: none"> <li>thermostat has activated</li> </ul>	<ul style="list-style-type: none"> <li>to make room cooler rotate thermostat counter-clockwise</li> </ul>
<b>The mains switch switches OFF</b>		<ul style="list-style-type: none"> <li>switch off the appliance and call Service Centre</li> </ul>
<b>The appliance does not cool the environment sufficiently</b>	<ul style="list-style-type: none"> <li>window open</li> <li>source of heat in room (heater, lamp etc.)</li> <li>room is overcrowded with people</li> <li>air exhaust hose has become disconnected</li> <li>thermostat regulated too high</li> <li>air filter blocked</li> </ul>	<ul style="list-style-type: none"> <li>close window</li> <li>re-insert exhaust hose</li> <li>Regulate the thermostat.</li> <li>clean filter</li> </ul>
<b>The appliance does not heat the environment sufficiently (mod. CT300H only)</b>	<ul style="list-style-type: none"> <li>The safety thermostat on the heating element has been activated.</li> </ul>	<ul style="list-style-type: none"> <li>to reset the unit, disconnect it from mains for a few minutes, eliminate the cause of overheating and then reconnect.</li> </ul>

---

## SERVICING

In case of malfunction turn off and disconnect the air-conditioner from power outlet and contact the nearest Service Centre for qualified assistance.



### **Periodic Servicing (IMPORTANT)**

**This appliance should be de-scaled whenever the calcium deposit becomes excessive (on average after 400 operating hours) or in any event at least once every season.**

### **INSTRUCTIONS FOR DE-SCALING**

You will need: 1/4 liter de-scaling fluid  
(supplied with appliance)  
1 liter clean water  
= **80% dilution**

- a) Remove the container from the unit and drain away any water left in the collecting tray with the drainage tube.
- b) Seal the drainage tube. Pour 1/4 liter of de-scaling fluid and 1 l clean water into the collecting tray situated under the container, at the bottom of the unit.
- c) Leave the air-conditioner to operate for about half an hour.
- d) Drain away all the fluid left in the tray and rinse thoroughly. The drainage tube should be open and the appliance switched on during draining.
- e) Disconnect the plug from the mains and clean the collecting tray thoroughly with a clean cloth.
- f) Once the tray is clean, the appliance can resume normal operation.

IF, WHEN RESTARTING THE APPLIANCE AFTER CLEANING, TRACES OF FOAM ARE FOUND IN THE WATER, THIS IS NORMAL. IF HOWEVER A LARGE QUANTITY OF FOAM IS NOTED, RINSE THE APPLIANCE ONCE AGAIN.

FURTHER SUPPLIES OF DE-SCALING FLUID CAN BE OBTAINED FROM YOUR LOCAL DE LONGHI SERVICE CENTRE.

### **ATTENTION**

The use of products other than those supplied by De Longhi may cause damage to interior components, thereby invalidating the guarantee.